

FurBabyFeeder Automatic Microchip Pet Feeder



User Manual

What's in the box

- ① 1 x Microchip Pet Feeder
- ② 1 x Pet Bowl
- ③ 2 x RFID Tags
- ④ 1 x DC 5V USB Cable

Welcome to Your New Pet Feeder

- 1) The Smart Automatic Microchip Pet Feeder can identify by the included RFID Collar Tag, letting your pet block other animals while accessing their food, pets can reduce the spread of disease, specifically for the use of multiple pet families.
- 2) Pet owners attach the RFID tag on their pets to allow them to open the feeder; unauthorized pets will not be able to open the feeder.
- 3) The pet feeder with infrared Sensor can identify the pets and open the lid automatically.
- 4) The feeder keeps food fresh for a long time, keeps food from spoiling, and reduces the risk of disease spread by flying insects.



Product Introduce

Setting up the feeder to work in your home just takes few steps, detail setting steps is in this user manual. We will guide you from inserting the batteries to teaching you how to use the feeder.

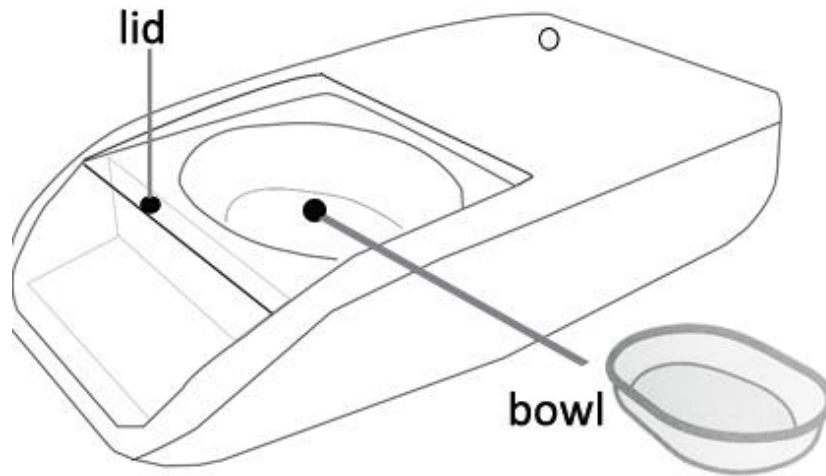

① The front of the feeder

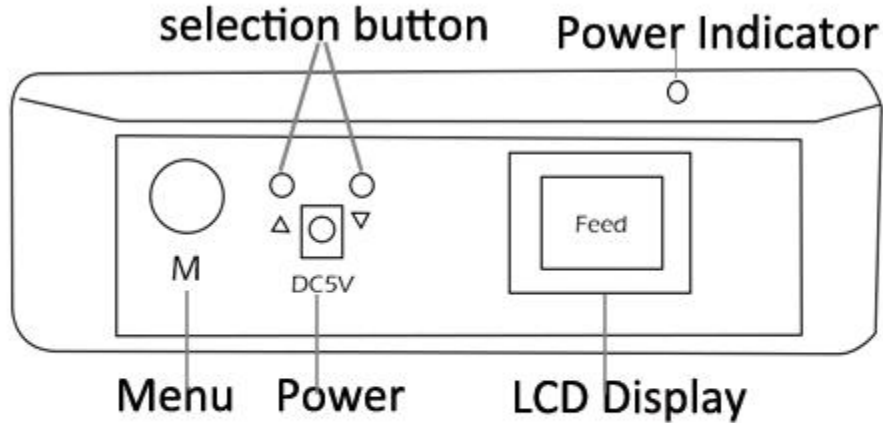

② The back of the feeder



Batteries

Always use **4 good quality 1.5V C Cell batteries**. This will ensure the best performance of your feeder. **This product is not designed for use with rechargeable batteries.** The light at the back of the feeder will flash red every few seconds if the batteries are low. **USB charging is recommended for best performance.**

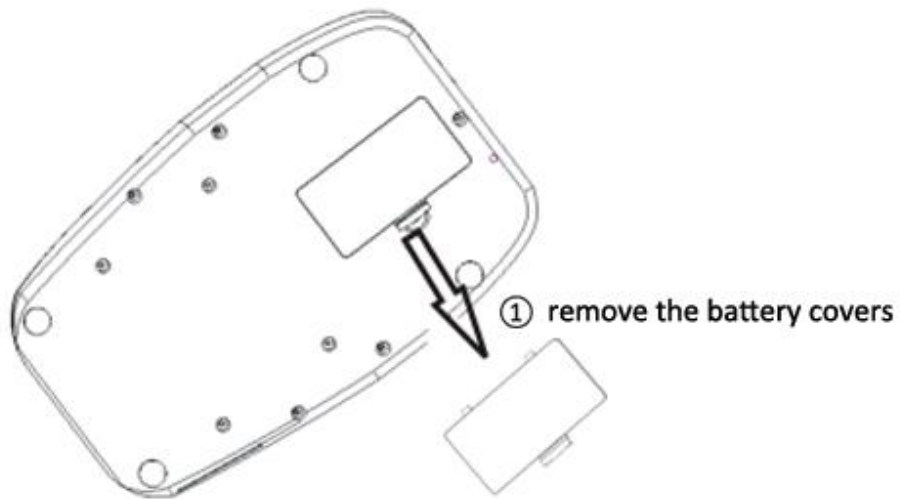

After the batteries installed, the light at the back of the feeder will be in red.

Except for use batteries, **the Microchip Pet Feeder also supports DC5V USB power**, please choose the best way at your convenience.



How to set the Pet Feeder

1, Power on the feeder (machine light in red)

2, Menu Settings

Press “**M**” button, go into the menu setting, press “**Δ**” “**∇**” button to choose the function, press “**M**” confirmed the chosen function.

Main Menu as below:

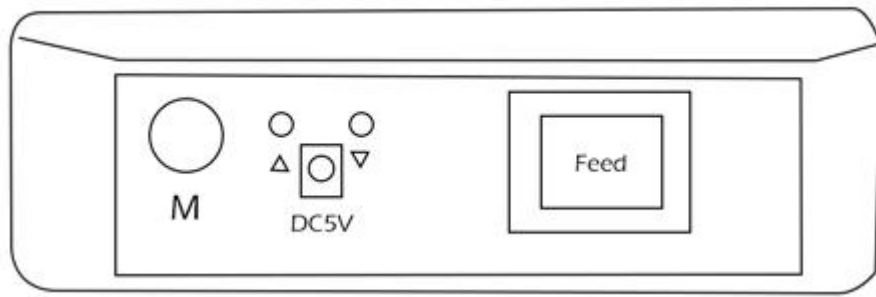

1. Write ID Setting

This function is help to write the RFID tag for the pets, thus only pet with the tag can open the feeder and eaten food.

Put the tag that you want to write ID near the feeder, Press “M”, choose “Write ID”, press “Δ” “▽” to choose “YES”, then choose “Cancel” exit. If write ID successful, light is in green, if write ID failed, light is in red.

See Picture 6.

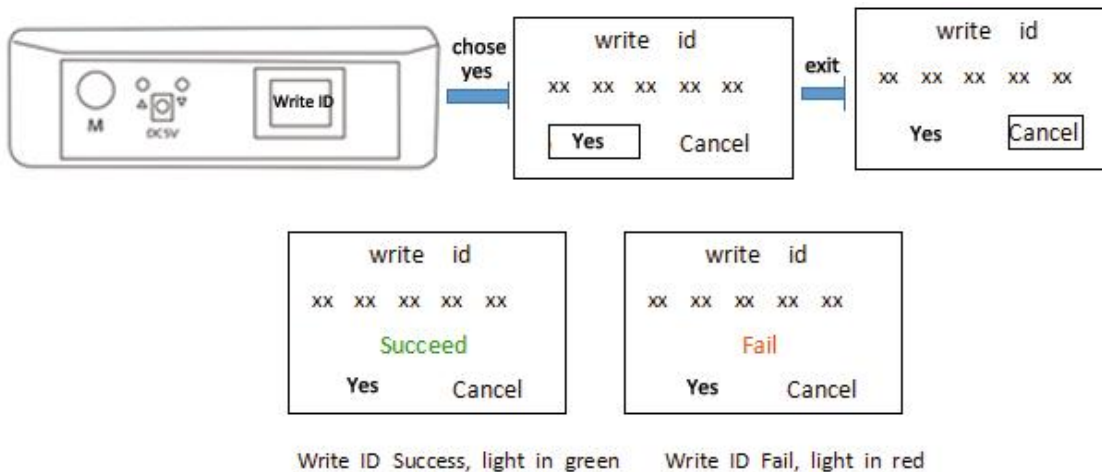

Write ID Success, light in green Write ID Fail, light in red

Picture 6

Note: when “write ID”, please make sure the collar tag on the top of the feeder but not on the same side of the screen in case “write ID” failed.

2. Delete ID Setting

If you want to delete the data of the tag, put the tag near the feeder, press “M”, choose “Delete ID”, press “▲” “▼” to choose “YES”, then choose “Cancel” exit.

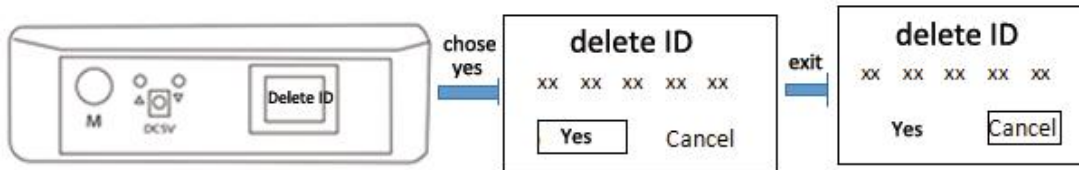

Note: when “delete ID”, please make sure the collar tag on the top of the feeder but not on the same side of the screen in case “delete ID” failed.

3. Open Door Setting

If you want to add or replace food or want to clean the bowl, then you may need to open the lid, while the lid was authorized by RFID tag, in this case, you can choose the menu” **Open Door**”. Like below



Picture 8

4. Reset To Factory Setting

This will reset the current feeder to factory default and delete all current stored settings.

Press “▲” “▼” to choose Factory Setting, Press “M” to enter, Press “▲” “▼” choose Yes, then Press” M ” to save. Then choose Cancel with “M” to exit.

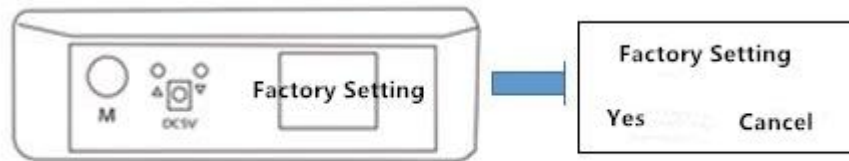

Picture 9

5. System Info

Press “▲” “▼” choose System Info, then press “M” to enter, it will show the current version, like V1.3.4 2022 10 28(Version NO. & Date), then press “Cancel with “M” to exit.

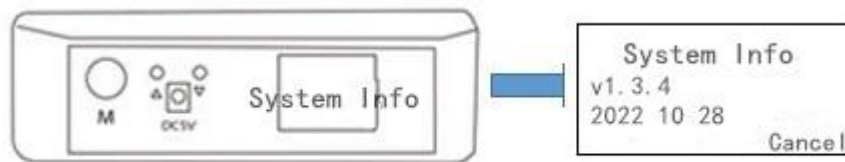

Picture 10

6. Suggested Training Mode

If your pet is hesitant or scared of the feeder, we suggest you open the door and unpower / unplug the feeder to allow the pet to get comfortable during the feeding process. After a few meals you can power the feeder back on to enable "only allowed pets to eat". Please note this process will allow other pets to eat while training is in process.

7. Troubleshooting

- ▲ Please remove all the batteries and ONLY power via USB. Unplug for 10-15 seconds and power back by USB.
- ▲ Do a factory reset and rewrite each RFID tag.

Cleaning

It is important to keep your Pet Feeder clean to ensure it functions reliably. **Do not put the whole feeder into water or the dishwasher.**

Food can't be higher than the lid.

- ▲ The Pet feeder should be wiped with a damp cloth or household cleaning wipes.
- ▲ Pull out the lid , take out the bowl for clean and then pull in the lid.

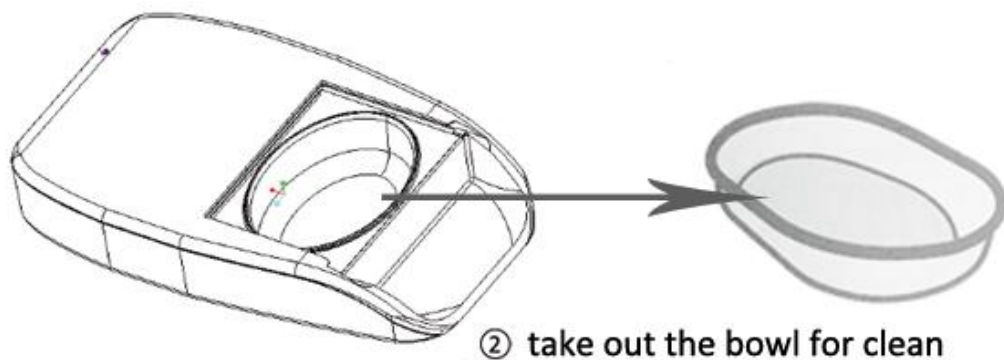
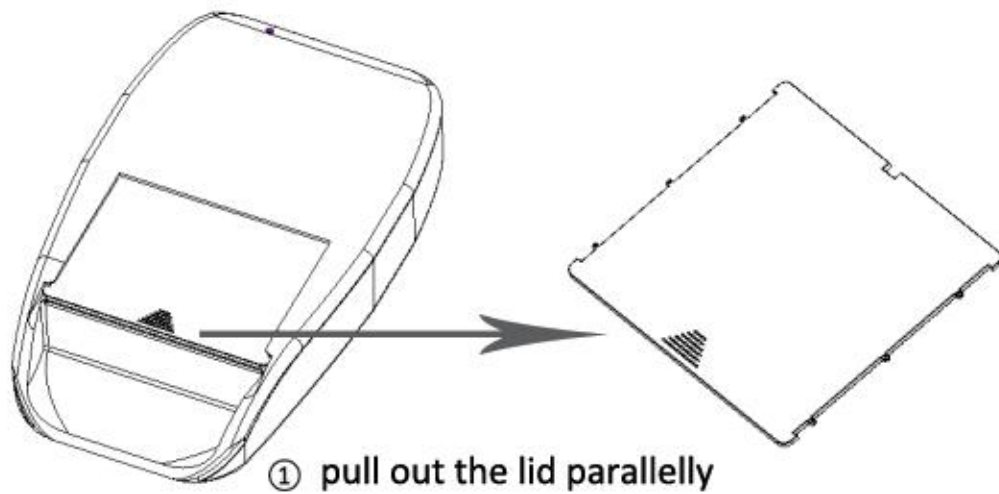



Where to place your feeder

- ▲ The feeder is designed for indoor use only.
- ▲ To prevent damage to your feeder (and yourself), do not place in areas where people are walking past frequently as it may cause a trip hazard.
- ▲ Place near metallic/electrical appliances is normally not a problem. If unreliable operation occurs, please move the feeder away from the appliance.
- ▲ Do not place the feeder in fridge or put ice packs in the feeder.



Warranty & Disclaimer

* **Warranty**

The Pet Feeder carries a 1-Year USA Warranty from the date of purchase, subject to proof of purchase date. The warranty is restricted to any fault caused by defective materials, components or manufacture. This warranty does not apply to products whose defect has been caused by normal wear and tear, misuse, neglect or intentional damage.

In the event of a part failure due to faulty parts or workmanship, the part will be replaced free of charge during the warranty period only. At the manufacturer's discretion, a replacement product may be provided free of charge in the case of a more serious malfunction. Your statutory rights are not affected.

Follow us on Facebook <https://www.facebook.com/FurBabyFeeder>

Email: furbabyfeederservice@gmail.com

Web: www.furbabyfeeder.com



* Disclaimer

The Automatic Microchip Identify Pet Feeder incorporates selective access features which have been designed to minimize the risk of pets eating each other's' food. However, it is not possible to fully guarantee the exclusion of all other pets in all circumstances liability for any damage or inconvenience which may be incurred.



THE MANUFACTURER IS NOT RESPONSIBLE FOR ANY RADIO OR TV INTERFERENCE CAUSED BY UNAUTHORIZED MODIFICATIONS TO THIS EQUIPMENT. SUCH MODIFICATIONS COULD VOID THE USER'S AUTHORITY TO OPERATE THE EQUIPMENT.